

Numark®

Professional Disc Jockey Products

CDN-32S PROFESSIONAL DUAL CD PLAYER

with

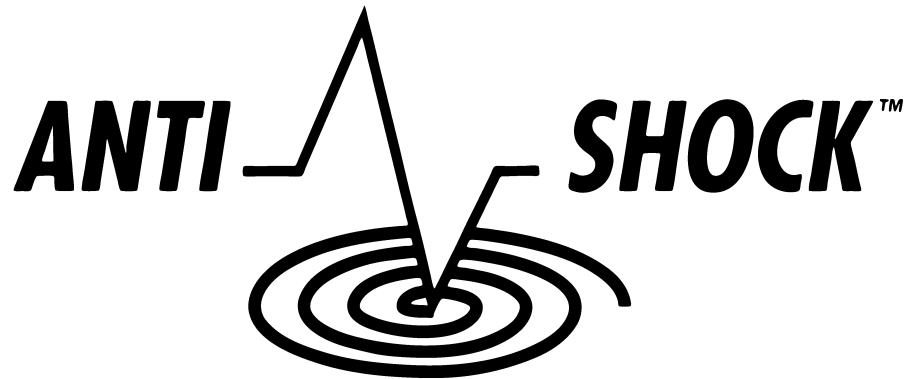

Buffered memory

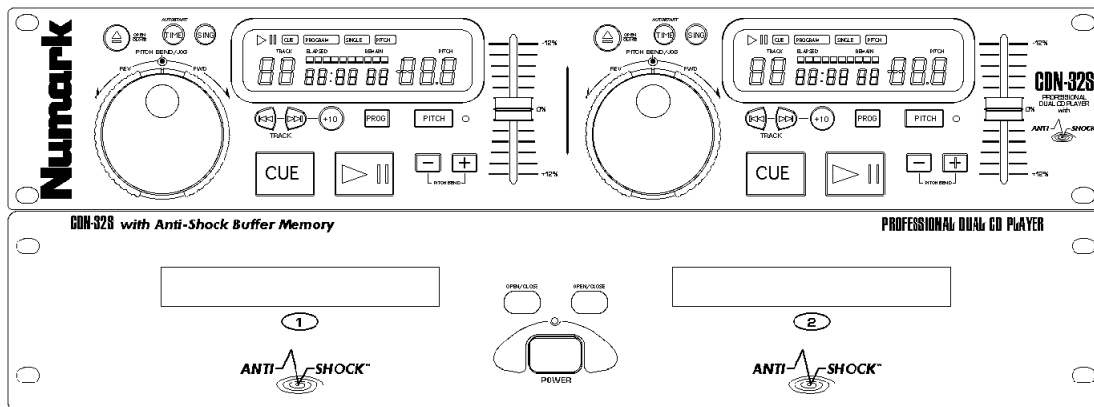

OPERATING MANUAL

Safety Information and Product Registration



CAUTION
RISK OF ELECTRIC SHOCK
DO NOT OPEN

CAUTION: TO REDUCE THE RISK OF ELECTRIC SHOCK DO NOT REMOVE ANY COVER. NO USER-SERVICEABLE PARTS INSIDE. REFER SERVICING TO QUALIFIED SERVICE PERSONNEL ONLY.

The lightning flash with arrowhead symbol within the equilateral triangle is intended to alert the user to the presence of un-insulated "dangerous voltage" within the product's enclosure that may be of sufficient magnitude to constitute a risk of electric shock.

The exclamation point within the equilateral triangle is intended to alert the user to the presence of important operating and maintenance (servicing) instructions in the literature accompanying this appliance.

CAUTION
FOR USA & CANADIAN MODELS ONLY
TO PREVENT ELECTRIC SHOCK DO NOT USE THIS (POLARIZED) PLUG WITH AN EXTENSION CORD, RECEPTACLE OR OTHER OUTLET UNLESS THE BLADES CAN BE FULLY INSERTED TO PREVENT BLADE EXPOSURE.

SAFETY INSTRUCTIONS

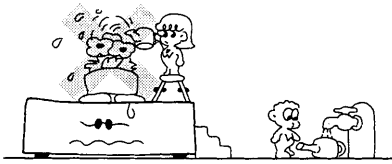
- 1) Read Instructions - All the safety and operating instructions should be read before this product is connected and used.
- 2) Retain Instructions - The safety and operating instructions should be kept for future reference.
- 3) Heed Warnings - All warnings on this product and in these operating instructions should be followed.
- 4) Follow Instructions - All operating and other instructions should be followed.
- 5) Water and Moisture - This product should be kept away from direct contact with liquids.
 
- 6) Heat - Avoid placing this product to close to any high heat sources such as radiators.

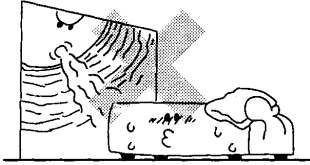
- 7) Ventilation - The appliance should be situated so that it's location or position does not interfere with its proper ventilation. For example, the appliance should not be situated on a bed, sofa, rug, or similar surface that may block the ventilation opening; or, placed in a built-installation, such as bookcase or cabinet that may impede the flow of air through the ventilation openings.
 

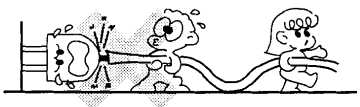
- 8) Power Sources - This product should be connected to a power supply only of the type described in these operating instructions, or as marked on the unit.
- 9) Power Cord Protection - Power supply cords should be routed so that they are not likely to be walked upon or pinched by items placed on or against them. When removing the cord from a power outlet, be sure to remove it by holding the plug attachment and not by pulling on the cord.
 

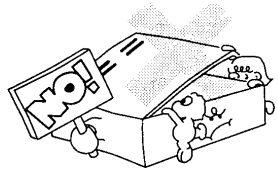
- 10) Object and Liquid Entry - Take care that objects do not fall into and that liquids are not spilled into the inside of the mixer.
- 11) Cleaning - The appliance should be cleaned only as recommended by the manufacturer.
- 12) Non-use Periods - The power cord of the appliance should be unplugged from the outlet when left unused for long periods of time.
- 13) Damage Requiring Service - only qualified personnel should service this product. If you have any questions about service please contact Numark at the number(s) shown on the back cover of this manual.
 

- 14) Grounding or Polarization - Precautions should be taken so that the grounding or polarization means built into the CD player is not defeated.
- 15) Internal/External Voltage Selectors - Internal or external voltage selector switches, if any, should only be reset and re-equipped with a proper plug for alternative voltage by a qualified service technician. Do not attempt to alter this yourself.

Numark- The Leader in DJ Technology

WARNING: To reduce the risk of fire or electrical shock, do not expose this appliance to rain or moisture. Electrical equipment should NEVER be kept or stored in damp environments.

DANGER: INVISIBLE LASER RADIATION WHEN OPEN AND INTERLOCK FAILED OR DEFEATED. AVOID DIRECT EXPOSURE TO BEAM.

CAUTION: This product utilizes a laser. Use of controls or adjustments other than those specified herein may result in hazardous radiation exposure.

SERVICE INSTRUCTIONS

- Disconnect power cord before servicing
- Replace critical components  only with factory parts or recommended equivalents
- For AC line powered units - Before returning repaired unit to user, use an ohmmeter to measure from both AC plug blades to all exposed metallic parts. The resistance should be no more than 100,000ohms.

NOTICE CONCERNING FCC REGULATIONS

This equipment generates and uses radio frequency energy and may cause interference to radio and television reception if you do not operate it in strict accordance with the procedures detailed in this OPERATING MANUAL.

This unit complies with Class B computing device rules in accordance with the specifications in Sub-part J or Part 15 of the FCC Rules, which are designed to provide reasonable protection against such interference in a residential installation. There is no guarantee, however, that interference will not occur in a particular installation. If the unit does cause interference to any radio or television reception, try to reduce it by one or more of the following means:

- a) Reposition the other unit and/or its antennae
- b) Move this unit
- c) Move this unit and the other unit(s) further apart
- d) Plug this unit into a different AC outlet so that it is on a different circuit from the other equipment.

This note is in accordance with Section 15.838 of the FCC Rules.

This unit does not exceed the Class B limits for radio noise emission from digital apparatus set out in the radio interference regulations of the Canadian Department of Communications.

DOUBLE INSULATED - When servicing use only identical replacement parts

For 220-volt use in USA, use NEMA style 220-volt plug. For other countries use proper plug for local outlet.

LINE VOLTAGE SELECTION

- 1) The desired voltage may be set with the VOLTAGE SELECTOR switch on the rear panel of the main unit, using a screwdriver.
- 2) Do not twist the VOLTAGE SELECTOR switch with excessive force as this may cause damage.
- 3) If the VOLTAGE SELECTOR switch does not move smoothly contact a qualified serviceman.

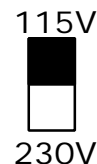

Please record the serial number of your unit as shown on the back of the chassis as well as the name of the dealer from whom you purchased the unit. Retain this information and your original purchase receipt for your records. Please return the enclosed warranty card to register your CD player with us.

MODEL: _____ PURCHASED FROM: _____
 SERIAL NUMBER: _____ DATE OF PURCHASE: _____

Numark- The Leader in DJ Technology

Numark® CDN-32S

PROFESSIONAL DUAL CD PLAYER

WITH



CONGRATULATIONS...

You have just purchased a dual CD player designed specifically for the professional DJ. This unit has been designed to provide CD mixing with the same ease and creativity that you have enjoyed with records. Please take a few moments to familiarize yourself with the CDN-32 by reading the following information before attempting to operate the unit.

Once again, congratulations and thank you for making the CDN-32 your choice in professional CD players.

FEATURES:

- Anti-Shock buffered memory
- True buffered instant start
- Interactive pitch wheel adjustment
- Fader/relay start
- Digital Output
- 3 speed scanning
- Frame search
- Auto cue
- +10 tracks skip search
- 30 tracks program play
- Pitch display
- 8 times oversampling
- 8cm single CD compatible

Numark - *The Leader in DJ Technology*

TABLE OF CONTENTS

| | |
|--|----|
| Safety and Registration | 2 |
| Introduction | 4 |
| Set-up Instructions & Connections | 7 |
| Description of the Features | |
| Remote Control Unit | 8 |
| Display | 9 |
| Transport | 9 |
| Basic Operation | |
| Play, Pause and Cue Operations | 10 |
| Matching the Tempo | 11 |
| Beat Matching Using Pitch Bend | 11 |
| Relay and Fader Start | 12 |
| Example of Mixing | 13 |
| Before Switching off the Power | 14 |
| Troubleshooting Guide | 14 |
| Information and Specifications | 15 |
| Warranty | 16 |

**CHECK TO BE SURE
THE FOLLOWING ITEMS ARE IN THIS BOX:**

- 1) DUAL-TRANSPORT PLAYER UNIT
- 1) REMOTE CONTROL UNIT
- 1) OWNERS MANUAL (THIS BOOKLET)
- 2) RCA CONNECTING CABLES
- 2) CONTROL CABLES
- 1) FADER START CABLE
- 1) IEC POWER CORD

Numark - *The Leader in DJ Technology*

DESCRIPTION OF ANTI-SHOCK BUFFER MEMORY

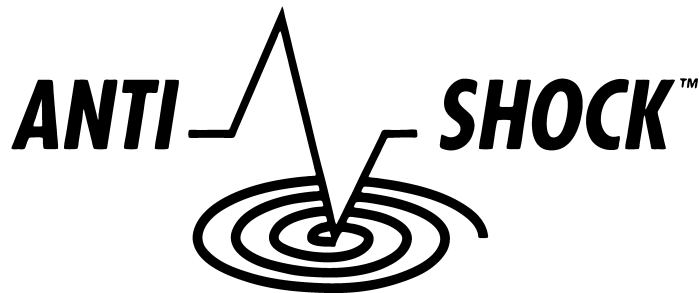

The CDN-32S is equipped with a total of 24 Seconds of RAM Buffer memory. 12 Seconds of this is used for the Anti-Shock Buffer and the other 12 are used for instant start functions. Anti-shock is to allow the unit to be bumped around **hard** for 6 seconds per side and not stop. When the CD is first placed in the tray and a track is selected, the CD player quickly reads the beginning of the track and stores it into a buffer memory, the same way a computer stores information in RAM. This initial operation takes about 5 seconds. As you play the track, the CD Player continues to read ahead of the music and stores this information in the buffer. If the unit is bumped the CD Player will continue to play from this buffer until the unit recovers and can start filling the buffer again. The buffer should be long enough to allow recovery from most situations, however, continual shocks can erase the buffer memory. If the unit should ever run out of buffer and still be receiving shocks, then the last 2 seconds will repeat until continuation can occur. ***The music never stops.***

NOTE: The CD player can not store buffer information during the setting of a cue point with the jog wheel. If you start a CD without giving it an opportunity to load the buffer it will still start instantly and load buffer slowly. It will recover 1 second of buffer for every 6 seconds of music played at 0% pitch.

CONNECTIONS

Typical connection with a mixer is illustrated right.

1. Connect the output connection cords from the CD Player to the line inputs of your mixer.
2. Connect the remote control connection cable from the Unit 1 connector on the main unit to the Unit 1 connector on the remote control unit. Repeat for Unit 2.
3. The output connection cords and the remote control connection cables are supplied with the main unit. Be sure to use the remote control connection cables which have been supplied. Use of another cable type might cause damage.

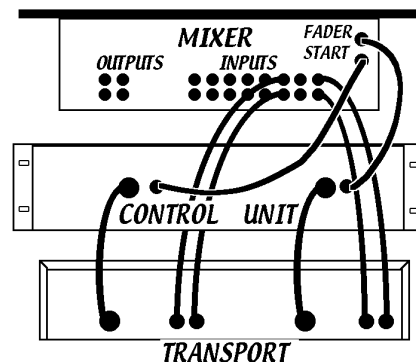

4. Connect Relay or Fader start cables
 - For fader start attach both side of your CD play to a similarly equipped DJ mixer, as in the top drawing.
 - For relay capability take the autostart cable and connect the two jacks in the rear of your CD player.

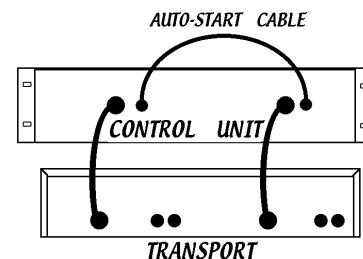
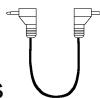

POWER ATTACHMENT: Your CD player is equipped with an IEC style power connector. Please first select the proper voltage for your location. Next, plug in you supplied power cable into the rear of the unit then plug into the appropriate power outlet.

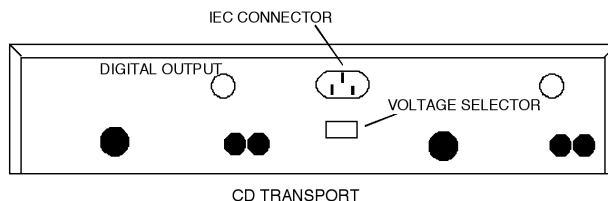

DIGITAL OUTPUTS: This CD player is specially equipped with digital outputs. The format is type 2, form 1, also known as S/PDIF (Sony/Phillips Digital Interface Format). In order to use the digital output you must activate the rear panel switch. When the digital output is active the variable pitch slider and pitch bend buttons or pitch wheel will not work.

Note: If digital information was allowed to change in pitch, other devices will not read the digital output properly.

MOUNTING YOUR CD PLAYER

- Mount the units in your console or rack with 19" EIA rails
- The transport should be mounted not to exceed an angle of 15 degrees.
- Your CD player can be affected by excess vibration so mount the units in a secure environment if possible.

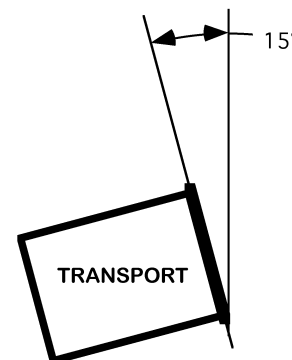

Numark- The Leader in DJ Technology

DESCRIPTION CDN-32S REMOTE FEATURES

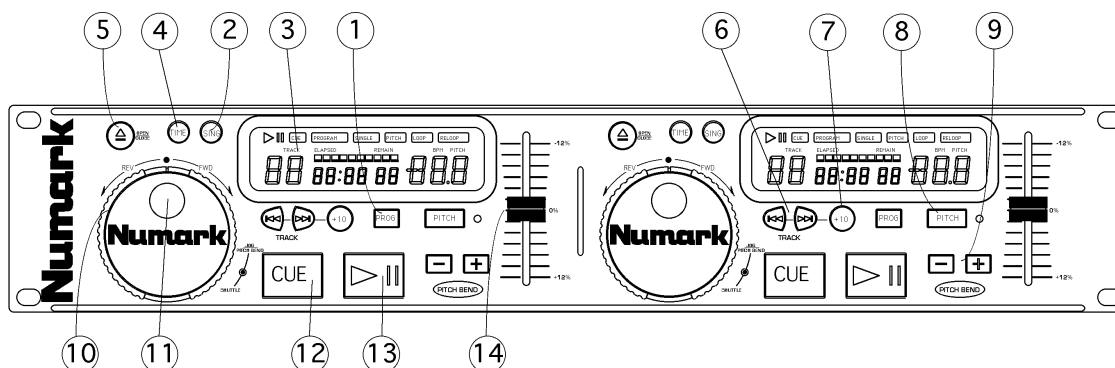

1. **PROGRAM** - Depress this button and the unit will stop and the program indicator will light. Select each track to be programmed and press the PROGRAM button between selections. You can program up to 30 tracks. Press PLAY to start the program. To exit and erase program hold the program button down for more than 2 seconds while the unit is stopped, open the disc tray, or turn off the power.
2. **CONT/SING** - Will cause just a single track to play or all tracks in order by pressing once or twice.
3. **LCD DISPLAY** - Indicates all the functions, as they are occurring, with the CD. These functions are explained in the next section.
4. **TIME (Time Button)** - The TIME button switches the time display between elapsed playing time and remaining time on the track. Holding for more than one second activates auto-start functions.
5. **OPEN/CLOSE (Disc Tray Open/Close)** - Press to load or eject the disc. Each press will open or close the disc tray on the transport. NOTE: Tray will not open unless the disc has been paused.
6. **TRACK (Track Buttons)** - These buttons are used to select the track to be played.
7. **Track 10 Button** - This button is for quickly advancing to higher tracks on a CD.
8. **PITCH (Pitch Button)** - This button activates the Pitch Slider (14).
9. **PITCH BEND (Pitch Bend Button)** - When each of the two CD players is playing a CD, the pitch bend function allows the positioning of the bass beats to be matched after the pitch of each disc is matched. Either player can "catch up" or "fall back" to match the other player. The pitch will automatically rise while the + button is pressed (allowing "catch up") and return to the original pitch when the button is released. The pitch will automatically drop while the button is pressed (allowing "fall back") and return to the original pitch when the button is released. By changing the pitch of one disc with respect to the other in this way the beats can be matched.
10. **SEARCH WHEEL (OUTER RING)** - This wheel has 3 forward and 3 reverse speed positions for searching through songs. The more you turn the wheel in either direction the faster you search through the music.
11. **JOG WHEEL (INNER RING)** - This jog wheel serves 2 functions depending on the current mode.
 - a) The jog wheel will act as a slow frame search control when the CD is not playing but either paused or set to a cue point. To set a new frame cue point, spin the wheel then press play when you have determined the proper position. Press CUE to return to the "CUE POINT".
 - b) The jog wheel will temporarily bend the pitch of the music if the song is already playing by rotating the wheel clockwise to speed up or counterclockwise to slow down.
12. **CUE** - Pressing the CUE button during play provides a return to the position at which play was started. If PAUSE is used before CUE, that will become the cue point. Alternately pressing the PLAY button and the CUE button allows the CD to be played from the same position any number of times. The CUE LED will light up from the time the CUE button is pressed until the CD has reset to the position at which play was started. Steady lighting of this LED indicates the ready condition.
13. **START/PAUSE (Play/Pause Button)** - Each press of the Play/Pause Button causes the operation to change from play to pause or from pause to play.
14. **PITCH SLIDER** - The pitch can be changed up to +/- 12% by pressing the PITCH button so the PITCH LED is lit, then moving the sliding fader. The pitch will not be changed if the PITCH LED is off.

Numark - The Leader in DJ Technology

LCD DISPLAY FEATURES

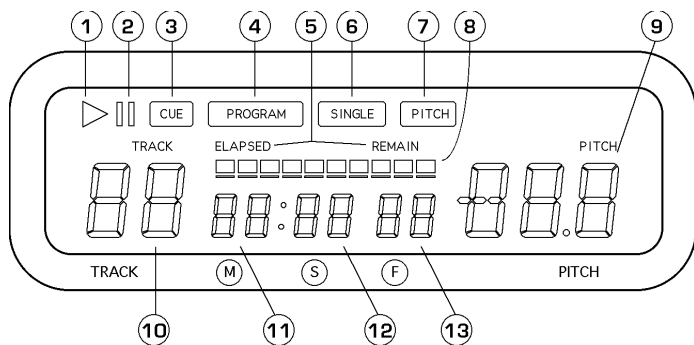

- c) **PLAY** - Active while the unit is actually playing a CD.
- d) **PAUSE** - Active when the unit is paused.
- e) **CUE** - Flashing when the unit is setting a cue point. Lit continuously when the unit is paused at a cue point.
- f) **PROGRAM** - Used for preprogramming the track order to automatically be played by the unit. This is a great function if you need to leave the CD player alone.
- g) **TIME MODE** -
(Elapsed) is for showing time as it is taking place.
(Remain) shows how much time is left on a particular track. This function is controlled by the TIME BUTTON (4).
- h) **SINGLE** - Shows when the unit is set to play just one track at a time. When this is not lit the CD will play continuously through all tracks. This function is controlled by the SING/CONT BUTTON (2).
- i) **PITCH** - Is lit when the PITCH BUTTON is active.
- j) **TIME BAR** - Shows either time remaining or elapsed depending on the setting of the TIME BUTTON (4).
- k) **PITCH** - Shows the percentage change in pitch.
- l) **TRACK** - Shows the track that the unit is playing with.
- m) **MINUTES** - Shows the minutes elapsed or remaining depending on mode setting.
- n) **SECONDS** - Shows the seconds elapsed or remaining depending on mode setting.
- o) **FRAMES** - The CD Player breaks down a second into 75 frames for accurate cueing. This shows the frames elapsed or remaining depending on mode setting.

TRANSPORT FEATURES

- 19. **DISC TRAY** - Place your CD in here.
- 20. **OPEN/CLOSE (Disc Tray Open/Close)** - Press to load or eject the disc. Each press will open or close the disc tray on the transport. NOTE: Tray will not open unless the disc has been paused.
- 21. **POWER BUTTON** - Turn on and turn off the machine from this button. The unit should always be shut down with this button first before any external power is removed.
- 22. **RCA AUDIO JACKS** - Connect your CD player to your mixer from this line level output.
- 23. **VOLTAGE SELECTOR** - Set this switch to the voltage for your location.
- 24. **IEC POWER CONNECTOR** - Plug your supplied power cord into here then plug unit into a power outlet.
- 25. **CONTROL CONNECTOR** - Plug your control cables for each unit into here and the back of the remote unit.
- 26. **DIGITAL OUTPUTS** - The format is type 2, form 1, also known as S/PDIF (Sony/Phillips Digital Interface Format). In order to use the digital output you must set the digital output selector to on. This will deactivate the variable pitch slider and the pitch bend buttons or pitch wheel. *If you were able to adjust the pitch, other devices will not read the digital output properly.*

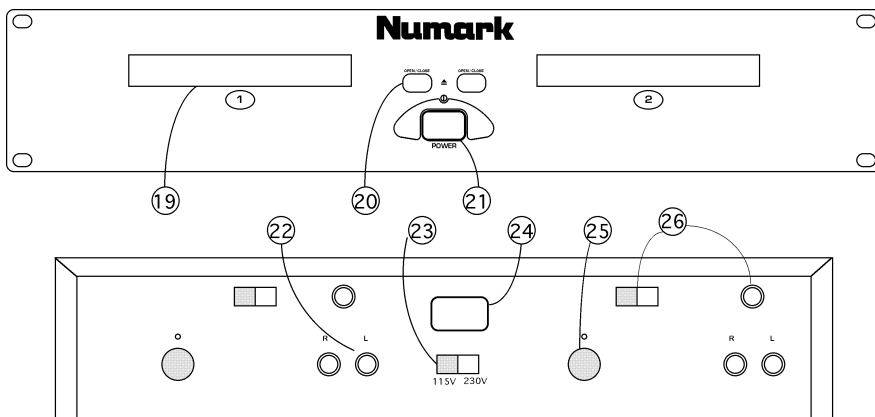

Numark - The Leader in DJ Technology

DESCRIPTION OF THE PLAY/PAUSE AND CUE OPERATIONS

PLAY and CUE

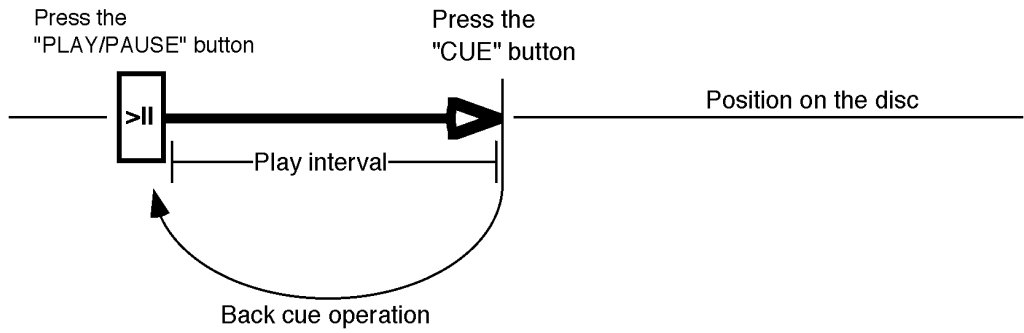

Pressing the “PLAY/PAUSE” button starts the disc. Pressing the “CUE” button will reset the disc to the last place where the disc was started. This is called the cue point. By alternately pressing the “PLAY/PAUSE” button and the “CUE” button, the disc may be returned and played from the cue point any number of times. This function is called back cue.

PLAY, PAUSE and CUE

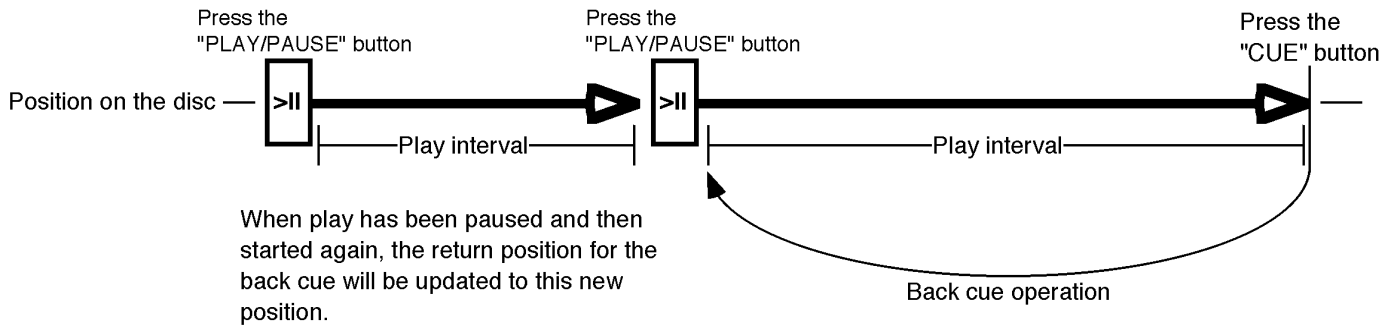

EDITING CUE POINT

When the inner search dial is turned while a cue point is set, a new cue point can be located. The CD player will repeatedly play small parts of the CD as you move it to the desired position. By pressing “PLAY/PAUSE” then “CUE” you can confirm that this new cue point is desirable

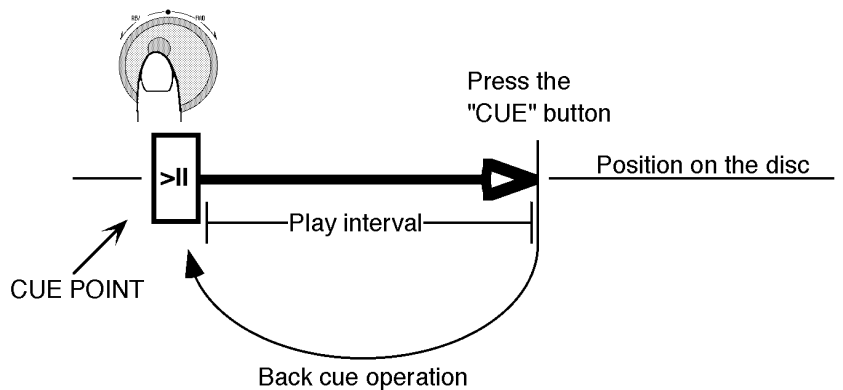

MATCHING THE BEATS PER MINUTE (BPM)

Match the tempo by monitoring the music of both PLAYER 1 and PLAYER 2 by ear and adjusting the pitch. When the tempo of the music of the selected CD player is slow compared to the tempo of the other player, move the slider to the (+) side and match the tempo. When faster, move the pitch slider to the (-) side. The following description is for the case of matching the pitch of PLAYER 2 to the pitch of the music being played on PLAYER 1.

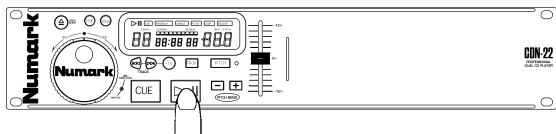

Press PLAY/PAUSE to start PLAYER 1
PLAYER 1 is playing

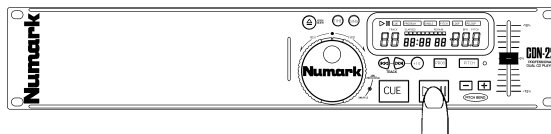

Press PLAY/PAUSE to start PLAYER 2
Both CD players are playing discs.

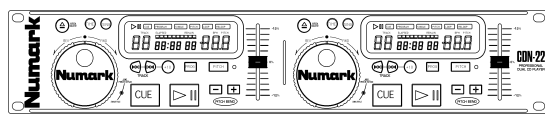

Listen to PLAYER 2 in your headphones

When PLAYER 2 is slow compared to PLAYER 1 speed up PLAYER 2

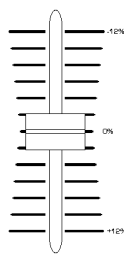

When PLAYER 2 is fast compared to PLAYER 1 slow down PLAYER 2

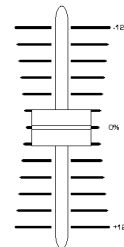

BEAT MATCHING USING PITCH BEND

If you find the BPM's (Beats Per Minute or Tempos) are the same, however, the drum beats are not matched you will need to temporarily change the pitch. This description is for the case of matching the beat of PLAYER 2 to the beat of the music being played on PLAYER 1. (This procedure can be done on either PLAYER).

After matching the BPM's adjust the pitch temporarily as follows:

When PLAYER 2 is ahead press the  or rotate the jog wheel counter clockwise

When PLAYER 2 is behind press the  or rotate the jog wheel clockwise

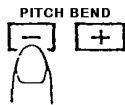

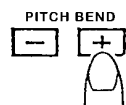
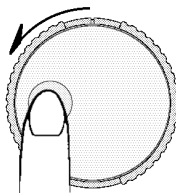

or

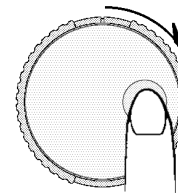

or



The pitch changes automatically while the  or  button is being pressed or the jog wheel is rotated. The faster you rotate the wheel the more you change. Releasing the button or wheel results in a return to the original pitch. (So the BPM's are once again the same.)

Numark - The Leader in DJ Technology

RELAY PLAY

The cables required are commercially available 3.5mm (1/8") mini-plug cables. One has already been included with your unit so the relay function could be used.

1. Connect auto start cable between both sides of the remote unit.
2. Insert CDs into both sides of the unit.

3. Hold down the time buttons for 1-2 seconds until the display indicates "auto" and the track number begins to flash. The track number will flash while the mode is active. Both sides must be active for relay to work.

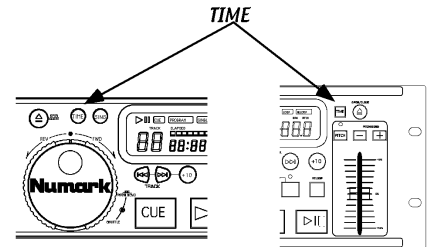

4. Put both sides in SINGLE play mode while learning this function.
5. Press play on CD1 of the unit. When that CD1 has finished play it will send a signal to CD2 to start play. You will see CD2 start play and CD1 pause and cue to the beginning of the next track. When CD2 has completed play CD1 will start.

Note: The play command is sent at the end of specified play. If the unit is in SINGLE mode the play command will start at the end of the track. If the unit is in CONTINUOUS mode the play command will be sent at the end of the full CD. Two CDs will play continuously, alternating from side to side. This feature will also work in program mode, however, if the sides are also in SINGLE mode the same number of tracks programmed should be the same. Play will stop at the end of the last track.

FADER-START MODE

This mode is achievable by attaching both sides of your CD player to a similarly equipped DJ mixer.

1. Connect cables between the CD remote unit and your DJ mixer.
2. Hold down the time button for 1-2 seconds to activate the fader start capability.
3. Follow the directions in your mixer manual

Typically if you move the crossfader toward the active channel, the attached CD player will activate. When it is moved away that side will cue, (similar to pressing the cue button).

EXAMPLE OF MIXING USING BOTH PLAYERS OF YOUR CD PLAYER

While playing a disc on PLAYER 1 load a disc into PLAYER 2 and select your next track, match its pitch to the track playing on PLAYER1 and when you are ready use the crossfader on your mixer to fade from PLAYER 1 to PLAYER 2.

Load a disc in PLAYER 1 and select the track and press PLAY.

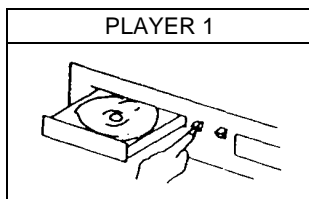

Load a disc and press the OPEN/CLOSE button.

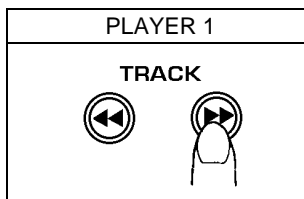

Select the track to be played.

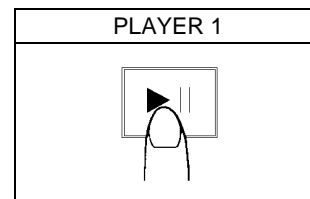

Press the PLAY button

Load a disc in PLAYER 2 and select the track then play.

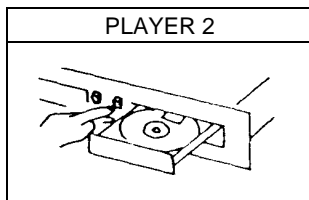

Load a disc and press the OPEN/CLOSE button.

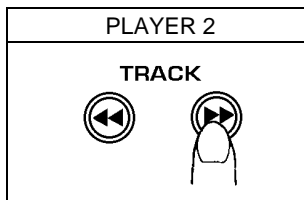

Select the track to be played.

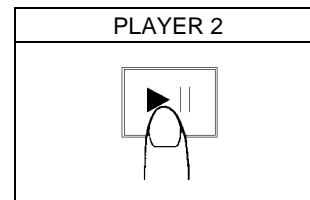

Press the PLAY button

Set and edit a start cue point on PLAYER 2

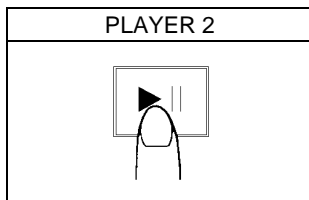

Press the Pause button of PLAYER 2.

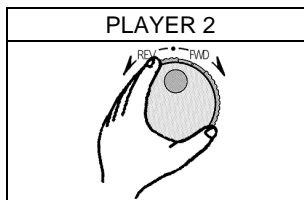

Rapidly search for a cue point using the outer wheel

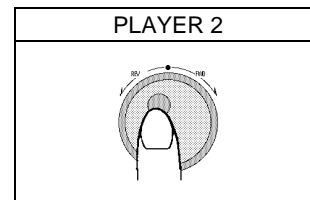

Slowly set the right point using the inner wheel

Check you new cue point

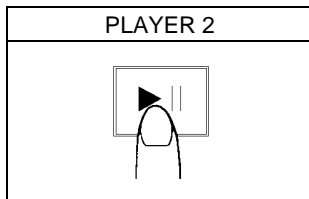

Listen with the monitor and press the play button.

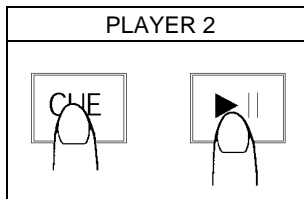

Press the cue button then play to be sure of the set cue point.

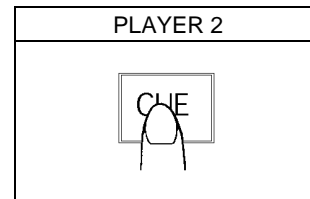

Set the player to the Cue point by pressing Cue

Do a MIX!

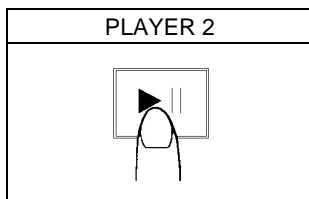

With a matching downbeat from Player 1 press the play button.

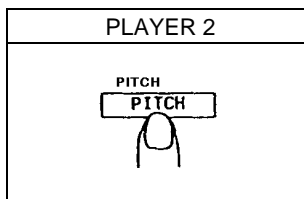

If you are beat mixing turn on your Pitch adjust and follow the directions for beat matching.

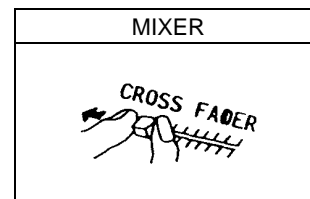

When you are happy with you mix adjust you mixer accordingly.

Numark- The Leader in DJ Technology

BEFORE SWITCHING OFF THE POWER:

When you have finished using the CD player, be sure that the disc tray is closed with the "OPEN/CLOSE" button before switching off the power.

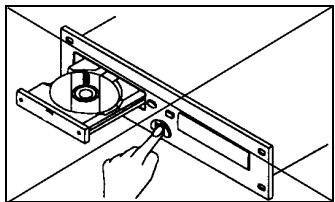

DO NOT switch off the power when the disc holder is open.

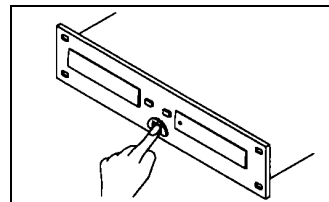

Switch off the power **after** the disc holder has been closed with the "OPEN/CLOSE" button

TROUBLESHOOTING:

| Symptom | Possible Cause | Corrective Action |
|---|---|---|
| The power fails to switch on when the POWER switch is set to on | Poor power plug connection at the AC outlet or IEC Power cord loose from rear of unit | Insert the power plug firmly into the AC outlet and make sure connection is good in unit rear |
| Disc play does not start | The disc is loaded upside down The disc is too dirty | Reload the disc with the label side up Clean the disc |
| No sound | Improper output cable connections Improper amplifier operation | Connect the output cables correctly Check amplifier setup |
| Sound skips | The CD player is subject to vibrations or physical shock The disc is too dirty | Change the installation location Clean the disc |
| Programmed disc play will not function | The CD player is in normal disk play mode | Hold down the Program button for 3 seconds then program the tracks |
| Hum | Loose cable connections | Firmly connect all audio plugs |

SPECIFICATIONS

TECHNICAL

| | |
|----------------------|---|
| Quantization | 16-bit linear/channel, 3 beam laser |
| Oversampling rate | 8 times |
| Frequency response | 20Hz-20KHz |
| Channel separation | 86dB |
| T.H.D. + NOISE | 0.01% |
| S/N ratio (IHF-A) | 94dB |
| Output level | 2.0Vrms |
| Short access time | |
| (Play next track) | less than 1.7sec |
| Long access time | |
| (Track 1 ->Track 20) | less than 3sec |
| Instant start | less than .015 sec |
| Pitch control range | +/-12% |
| Pitch bend | +/-16% |
| Digital Output | type 2, form 1, S/PDIF (Sony/Phillips Digital Interface Format) |

GENERAL

| | | |
|---------------------------|---------------|---|
| Dimensions: | Main Unit: | 482 (W) x 88.8 (H) x 264 (D) mm (without feet) 19 (W) x 3.5 (H) x 10 3/8 (D) inches (without feet) |
| | Control Unit: | 482 (W) x 88.8 (H) x 74 (D) mm (without feet) 19 (W) x 3 1/2 (H) x 2 7/8 (D) inches (without feet) |
| Weight: | Player Unit: | 5 Kgs., 11 lbs. |
| | Control Unit: | 2 Kgs., 4.4 lbs. |
| Power Supply: | | 115/230V AC, 50/60Hz |
| Power Consumption: | | 25W |

Numark- The Leader in DJ Technology

Numark[®]

Professional Disc Jockey Products

LIMITED PRODUCT WARRANTY

1. What is covered and for how long? NUMARK INDUSTRIES LCC ("NUMARK") warrants to the original purchaser that NUMARK'S DJ mixers and amplifiers are free from defects in material and workmanship under normal use and service for the period commencing upon the date of purchase from an authorized NUMARK dealer and continuing for the following period of time after that date for (2) Years. The warranty is extended to (3) Years with the completion of the warranty card provided that the warranty card is completed and returned within (30) days from the date of purchase. All other NUMARK products are warranted for (1) Year including but not limited to CD players, turntables, preamplifiers, beatkeepers, equalizers, microphones, headphones, and all other accessories.
2. What is not covered? This Limited Warranty is conditioned upon proper use of the product by the purchaser.
This Limited Warranty does not cover: (a) defects or damage resulting from accident, misuse, abuse, neglect, unusual physical or electrical stress, modification of any part of the product, or cosmetic damage; (b) equipment that has the serial number removed or made illegible; (c) all plastic surfaces and other externally exposed parts that are scratched or damaged due to normal use; (d) defects or damage from improper testing, operation, maintenance, installation, adjustment, or service of the mixers; (e) crossfaders.
3. What are NUMARK'S obligations? During the applicable warranty period, NUMARK will repair or replace, at NUMARK'S sole discretion, without charge to the purchaser, any defective component part of the mixer. To obtain service under this Limited Warranty, purchaser must first contact NUMARK and obtain a return authorization number ("RA#"). Purchaser must then return the mixer to NUMARK in an adequate container for shipping, accompanied by purchaser's sales receipt or comparable proof of sale showing the date of purchase, the serial number of the product, and the seller's name and address. To obtain an RA# and assistance on where to return the mixer, contact NUMARK customer service at 401-295 9000. Upon receipt, NUMARK will repair or replace the defective products. NUMARK may, at NUMARK'S sole discretion, use rebuilt, reconditioned, or new parts or components when repairing any product or replace a product with a rebuilt, reconditioned or new product. Repaired mixers will be warranted for a period equal to the remainder of the original Limited Warranty on the original mixer or for (90) days, whichever is longer. All replaced parts, components, boards and equipment become the property of NUMARK. If NUMARK determines that any mixer is not covered by this Limited Warranty, purchaser must pay all parts, shipping, and labor charges for the repair or return of such mixer.
4. What are the limits on NUMARK'S liabilities? THE WARRANTIES GIVEN IN THIS LIMITED WARRANTY, TOGETHER WITH ANY IMPLIED WARRANTIES COVERING NUMARK MIXERS, INCLUDING WITHOUT LIMITATION ANY WARRANTIES OF MERCHANTABILITY OR FITNESS FOR A PARTICULAR PURPOSE, ARE LIMITED TO THE DURATION OF THIS LIMITED WARRANTY. EXCEPT TO THE EXTENT PROHIBITED BY APPLICABLE LAW, NUMARK SHALL NOT BE LIABLE FOR ANY SPECIAL, INCIDENTAL, CONSEQUENTIAL, INDIRECT OR SIMILAR DAMAGES, LOSS OF PROFITS, DAMAGES TO PURCHASER'S PROPERTY, OR INJURY TO PURCHASER OR OTHERS ARISING OUT OF THE USE, MISUSE OR INABILITY TO USE ANY NUMARK MIXER, BREACH OF WARRANTY, OR NEGLIGENCE, INCLUDING BUT NOT LIMITED TO NUMARK'S OWN NEGLIGENCE, EVEN IF NUMARK OR ITS AGENT HAS BEEN ADVISED OF SUCH DAMAGES, OR FOR ANY CLAIM BROUGHT AGAINST PURCHASER BY ANY OTHER PARTY. THIS LIMITED WARRANTY IS THE COMPLETE WARRANTY FOR NUMARK'S MIXERS, AND IS GIVEN IN LIEU OF ALL OTHER EXPRESS WARRANTIES. THIS LIMITED WARRANTY SHALL NOT EXTEND TO ANYONE OTHER THAN THE ORIGINAL PURCHASER OF THIS PRODUCT AND STATES PURCHASER'S EXCLUSIVE REMEDY. IF ANY PORTION OF THIS LIMITED WARRANTY IS ILLEGAL OR UNENFORCEABLE BY REASON OF ANY LAW, SUCH PARTIAL ILLEGALITY OR UNENFORCEABILITY SHALL NOT AFFECT THE ENFORCEABILITY OF THE REMAINDER OF THIS LIMITED WARRANTY WHICH PURCHASER ACKNOWLEDGES IS AND WILL ALWAYS BE CONSTRUED TO BE LIMITED BY ITS TERMS OR AS LIMITED AS THE LAW PERMITS. This Limited Warranty allocates risk of product failure between purchaser and NUMARK, and NUMARK'S product pricing reflects this allocation of risk and the limitations of liability contained in this Limited Warranty. The agents, employees, distributors, and dealers of NUMARK are not authorized to make modifications to this Limited Warranty, or make additional warranties binding on NUMARK. Accordingly, additional statements such as dealer advertising or presentation, whether oral or written, do not constitute warranties by NUMARK and should not be relied upon.
5. How does state law apply to this warranty? SOME STATES DO NOT ALLOW THE EXCLUSION OR LIMITATIONS OF INCIDENTAL OR CONSEQUENTIAL DAMAGES OR HOW LONG AN IMPLIED WARRANTY LASTS, SO THE ABOVE LIMITATIONS OR EXCLUSIONS MAY NOT APPLY TO PURCHASER.
6. This Limited Warranty gives you specific legal rights. You may also have other rights, which vary from one jurisdiction to another.

RETURN INFORMATION

- A Return Authorization number must be obtained from Numark through the address or phone numbers below.
- A copy of the original sales receipt must also be included for the equipment to be repaired under warranty.
- The faulty equipment must be packed in its original packaging.
- One additional outer layer of packaging must be included to ensure product safety. Failure to do so may inadequately protect the equipment in transit and, therefore, jeopardize the customer's warranty.
- Numark will not accept COD shipments and no call tags will be issued for merchandise return.
- Numark will not return repaired merchandise to customers by priority service, unless by written request at the customer's cost. Requests must be submitted in writing with merchandise returned.
- The defective Numark equipment should be sent, FREIGHT PREPAID with Return Authorization number clearly printed on the outer packaging and original sales receipt enclosed to:

Numark INDUSTRIES
Attention: Service Department
11 Helmsman Avenue
North Kingstown, RI 02852 USA

Phone: +1 (401) 295-9000
Fax: +1 (401) 295-5200
Web: www.numark.com