

Numark

Professional Disc Jockey Products

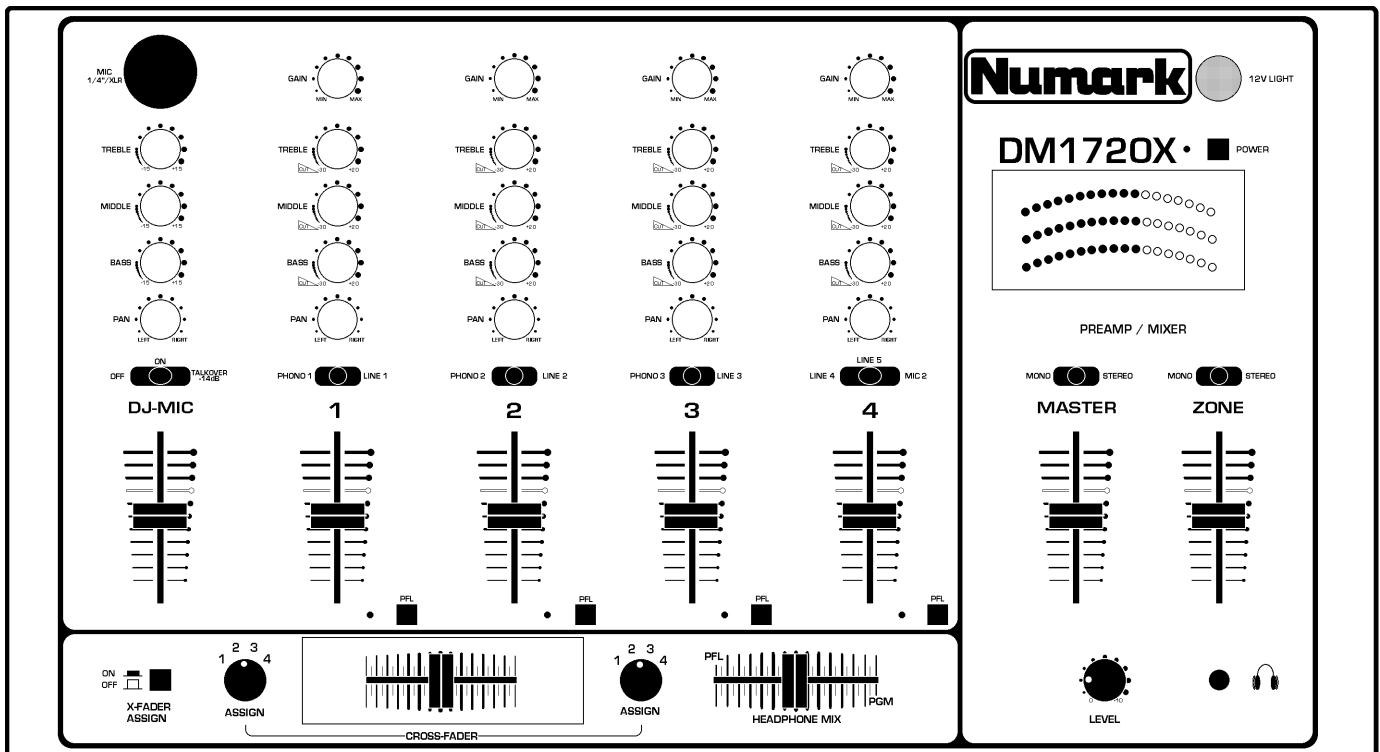

DM1720X STEREO MIXER OWNER'S MANUAL



NUMARK INDUSTRIES
11 Helmsman Road, North Kingstown RI 02852

<http://www.numark.com>

Safety Information and Product Registration

	CAUTION RISK OF ELECTRIC SHOCK DO NOT OPEN	
<p>CAUTION: TO REDUCE THE RISK OF ELECTRIC SHOCK DO NOT REMOVE ANY COVER. NO USER- SERVICEABLE PARTS INSIDE. REFER SERVICING TO QUALIFIED SERVICE PERSONNEL ONLY.</p> <p>The lightning flash with arrowhead symbol within the equilateral triangle is intended to alert the user to the presence of un-insulated "dangerous voltage" within the product's enclosure that may be of sufficient magnitude to constitute a risk of electric shock to persons.</p> <p>The exclamation point within the equilateral triangle is intended to alert the user to the presence of important operating and maintenance (servicing) instructions in the literature accompanying this appliance.</p>		

CAUTION FOR USA & CANADIAN MODELS ONLY
TO PREVENT ELECTRIC SHOCK DO NOT USE THIS (POLARIZED) PLUG WITH AN EXTENSION CORD, RECEPTACLE OR OTHER OUTLET UNLESS THE BLADES CAN BE FULLY INSERTED TO PREVENT BLADE EXPOSURE.

SAFETY INSTRUCTIONS

1. Read Instructions - All the safety and operating instructions should be read before this product is connected and used.
2. Retain Instructions - The safety and operating instructions should be kept for future reference.
3. Heed Warnings - All warnings on this product and in these operating instructions should be followed.
4. Follow Instructions - All operating and other instructions should be followed.
5. Water and Moisture - This product should be kept away from direct contact with liquids.

6. Heat - Avoid placing this product too close to any high heat sources such as radiators.

7. Power Sources - This product should be connected to a power supply only of the type described in these operating instructions, or as marked on the unit.

8. Power Cord Protection - Power supply cords should be routed so that they are not likely to be walked upon or pinched by items placed on or against them. When removing the cord from a power outlet be sure to remove it by holding the plug attachment and not by pulling on the cord.

9. Object and Liquid Entry - Take care that objects do not fall into and that liquids are not spilled into the inside of the mixer.

10. Damage Requiring Service - This product should be serviced only by qualified personnel. If you have any questions about service please contact **Numark** at the number(s) shown on the back cover of this manual.

11. Grounding or Polarization - Precautions should be taken so that the grounding or polarization means built into the mixer is not defeated.

12. Internal/External Voltage Selectors - Internal or external voltage selector switches, if any, should only be reset and re-equipped with a proper plug for alternative voltage by a qualified service technician. Do not attempt to alter this yourself.

NOTE: This apparatus does not exceed the Class A/Class B (whichever is applicable) limits for radio noise emissions from digital apparatus as set out in the radio interference regulations of the Canadian Department of Communications.

WARNING: To reduce the risk of fire or electric shock, do not expose this appliance to rain or moisture. Electrical equipment should NEVER be kept or stored in damp environments.

Please record the serial number of your unit as shown on the back of the chassis as well as the name of the dealer from whom you purchased the unit. Retain this information for your records. Please return the warranty card enclosed to register your mixer with us.	
MODEL: DM1720X	PURCHASED FROM: _____
SERIAL NUMBER: _____	DATE OF PURCHASE: _____

NUMARK DM1720X STEREO MIXER

INDEX

Safety Information Product Registration	Page 2
Introduction and Features	Page 4
Precautions	Page 5
Front Panel Diagram	Page 6
Rear Panel Diagram	Page 8
Connection Instructions	Page 9
Connection Diagram	Page 9
Specifications	Page 10
Block Diagram	Page 11
Warranty and Service	Page 12

CONGRATULATIONS!

You have purchased the **DM1720X** Stereo Mixer by **Numark**. This equipment features all new circuitry and the latest in manufacturing and design technology to give you greater quality and better reliability than ever before. The **DM1720X Preamp Mixer** has been designed by DJs for DJs. It gives you all of the controls and features you need in a professional piece of equipment to show off the best of your skills.

Thank you for buying Numark DJ products!

FEATURES...

- *User replaceable assignable ALPs™ crossfader .*
- *Bass, Mid, Treble, and Gain controls on every input channel.*
- *Left<->Right Pan control on each channel and the DJ Mic.*
- **Neutrik™** “Combo” connector allows 1/4” or XLR plug to be used for DJ Mic.
- *3 Phono and 5 Line inputs.*
- *Pushbutton Cueing with PFL (pre-fader listen) on each channel.*
- *Headphone monitoring with PFL/Program cross-fader.*
- *Master and Zone outputs.*
- *Stereo/Mono switch on the Master and Zones.*
- *Tape Out for direct recording.*
- *Powerful stereo headphone output.*
- *High-end performance audio signal.*
- *12V BNC light connector.*

As a special bonus we have included a right angle headphone adapter with this mixer. Just plug your headphones into the adapter and then plug the adapter into your mixer.

Numark - The Proven Leader in DJ Technology

IMPORTANT INFORMATION...

Please read this entire manual before connecting the DM1720X to your system.

For optimum performance:

- Always make sure that AC power is OFF while making any connections.
- Do not use excessively long cables (i.e. over 50ft/14m) Be sure plugs and jacks are tightly mated. Loose connections can cause hum, noise or intermittents that could easily damage your speakers.
- Never use spray cleaners on the slide controls. Residues cause excessive dirt build-up and this will void your warranty. In normal use slide controls can last for many years. If they malfunction (usually because of a dirty or dusty environment) consult a professional technician.
- Never attempt to make any adjustments or repairs other than those described in this manual. Take the **DM1720X** to your dealer or to an authorized **Numark** Service Center.

A NOTE ON CABLES:

Make the input and output connections with readily available *low-capacitance* stereo cables. Quality cable makes a *big* difference in audio fidelity and punch. Use balanced connections whenever possible. See your **Numark** dealer or an electronics or audio specialist store if you are not sure which cables to get.

SYSTEM PRECAUTIONS

- Use appropriate cables throughout your system: Quality shielded audio cables and terminated shielded video cables, low-capacitance preferred. Speaker cables must be 14-gauge minimum; 12- or 10-gauge is better.
- Reliability will be enhanced through the use of banana connectors on the speaker wires. Observe correct speaker wire polarity. If in doubt, consult your **Numark** dealer or a qualified technician.
- Take care to connect only one cable at a time. Pay attention to the color-coded, labelled Input and Output jacks.
- ALWAYS remember: “**TURN AMPS ON LAST AND OFF FIRST**”. Begin with master faders or volume controls on minimum and the amplifier gain/input control(s) down. Wait 8 to 10 seconds before turning up the volume. This prevents transients which may cause severe speaker damage.
- Use restraint when operating controls. Try to move them slowly. Rapid adjustments could damage speakers due to amplifier clipping.
- **Avoid amplifier “clipping” at all costs:** this occurs when the red LEDs (usually on the front panel of most professional power amplifiers) start flashing. “**Clipping**” is when the power amplifier is distorting and working beyond it’s limits. Amplifier distortion is THE major cause of speaker failure.
- To prevent fire or shock hazard, do not expose the unit to rain or moisture. **Never place cans of beer, soda, glasses of water or anything wet on top of the mixer!**

DM1720X FRONT PANEL DIAGRAM...

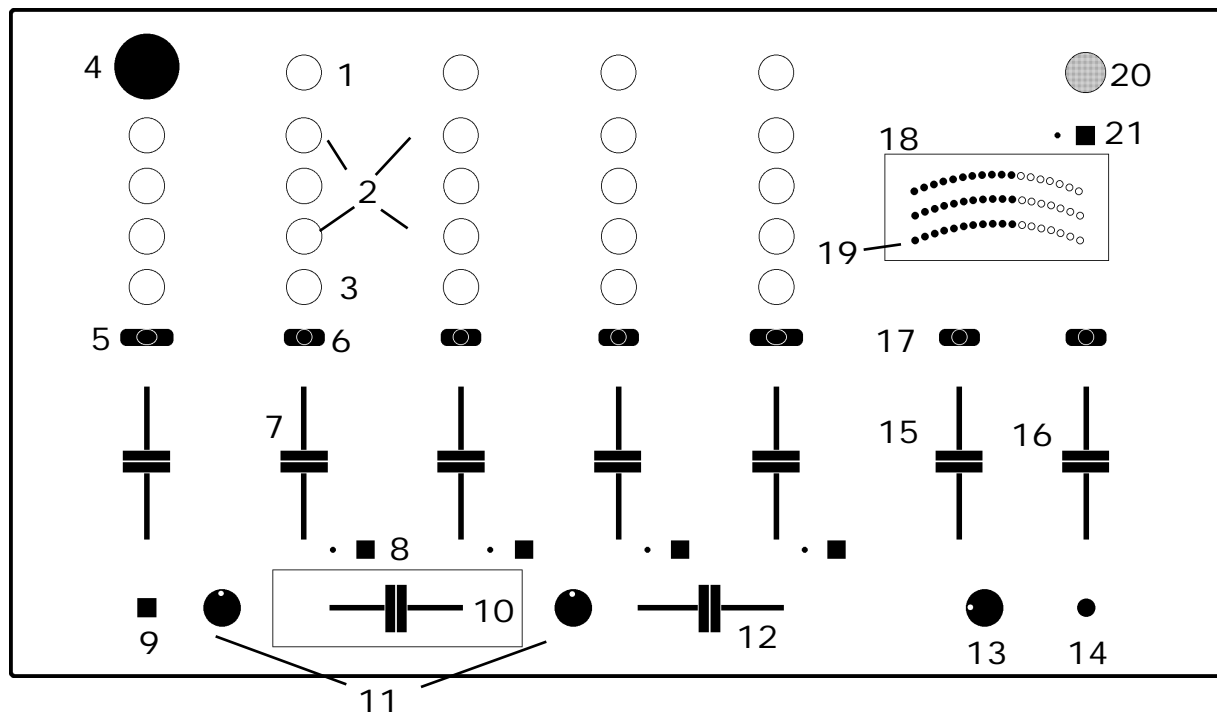

- Channel Input Gain/Trim/Attenuation Controls.**
These control the sensitivity of the inputs for Channels 1-4. Use these whenever a particular source causes overload of the preamp inputs. Attenuation range is 0dB to -20dB. Use these with the PFL (pre-fader listen) monitor when cueing.
- Treble, Middle and Bass Controls** fine tune the tone of your music through the sound system. Note that these are also available on the DJ Mic.
- Use the **Pan Control** to maximize the Left or Right side of your Source.
- The **Mic Jack** is a Neutrik™ “Combo Jack” and allows connection of either a 1/4” jack or an XLR jack. This is ideal for connecting an XLR Gooseneck directly.
- DJ Mic Talkover Switch.** When engaged this mutes your music sources from channels 1-4. Releasing it brings you immediately back to full source level. It is very useful for announcements.
- Channels 1 - 4 Input Toggle Switches** select which source will be live to that channel based on what you have connected to the rear panel input section.
- The **Input Faders** are low-noise, low-impedance, high-quality, smooth faders. These control individual source levels in the mix.
- Channel Cue Assign/PFL** pushbuttons are used to route channel audio to the **Monitor Section**. The channel input faders do not control the **Cue** volume. When the Cue button is pushed you get Pre Fader Listen(PFL). In addition, when these buttons are depressed the third row of the LED meter (19) will display the signal level of that channel on a PFL basis. The level can be adjusted by using the **Gain control(1)**.

Numark - The Proven Leader in DJ Technology

9. The **Crossfader In/Out Pushbutton** defeats the entire Crossfader function but leaves the Kill functions active.
10. The replaceable **Crossfader** achieves clean segues between two selected input channels.
11. The **Crossfader Channel Assign** switches determine which channels the crossfader will segue between.

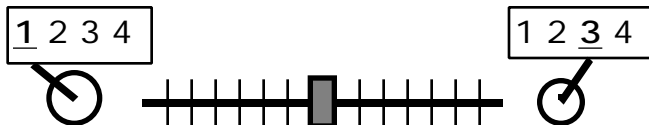

In this example, Channel 1 is selected on the Left and Channel 3 is selected on the Right. With the Crossfader centered both assigned channels are live. Use the Crossfader for fast and seamless segues from one channel to the next.

Note: *the crossfader is user replaceable. Simply unscrew the two large screws which hold it in place, lift it out, and disconnect its cable. Reattach the new crossfader and screw it back onto the unit - you're back in business!*
REPLACEMENT CROSSFADERS can be purchased from your local Numark Dealer, or by calling Numark Industries.

12. The **Split Cue Level** controls what signal is being monitored through your headphones. Move the slide control to the left and you will hear your source music from the channel(s) selected with the cue/PFL switch. Move the control to the right and you will hear your program mix, or output. The slide control allows fast and frequent headphone monitoring.
13. The **Headphone Level** control sets the volume in your headphones.
14. The **Headphone Jack** accepts a 1/4" plug and is set on the front of the unit.
15. **Master Level.** This controls overall output level. Note that you can select (18) whether you want stereo or mono.
16. The **Zone Levels** control speaker volume for other outputs such as control booth monitors, a tape deck, another amplifier, a sub-woofer, another mixer or a satellite speaker system. Note that you can select (18) whether you want stereo or mono.

CONTRACTOR'S NOTE: *Zone Level provides zone control in installations where there are two separate rooms (eg: a bar and a dance floor). The "Zone" volume should be controlled from the mixer not from the amplifier.*

17. The **Stereo/Mono Toggle Switches** allow you to select either stereo or mono output.
18. **Stereo Auto Peak Hold Level Meter.** The red LEDs for +3, +5 and +8dB hold program peaks for an instant. With peak metering, it's OK to be "in the red" as long as +5 or +8dB isn't constantly lit. Set crossover, equalizer and power amplifier inputs to avoid distortion at each step in the audio chain. Proper attention to the peak meters results in the punchiest possible sound without audible distortion.
19. **PFL Meter.** When the Cue/PFL switches are depressed this meter tracks pre-fader listen (PFL) signal for the channel selected instead of the mixer's output level.
20. **12V BNC Connector** allows a 12 volt gooseneck style "Numark" light to be connected directly to the mixer.
21. The **Power button** turns the unit on and off. Make sure your input faders (7) are turned down before you power up your mixer.

DM1720X REAR PANEL DIAGRAM...

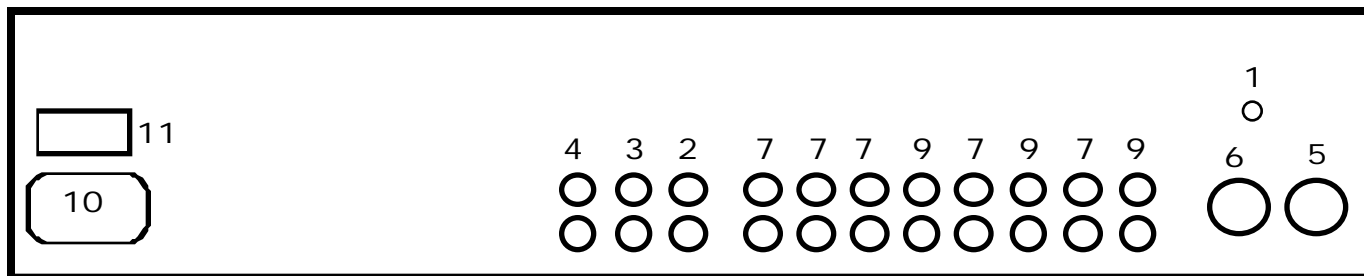

1. **GND** is the grounding lug for turntables 1, 2 and 3 (phono inputs on Channels 1, 2 and 3). Always use this connection (your turntable cable should have a grounding wire).

2. The **Stereo Main Outputs** are low-impedance RCA connectors controlled by the **Master** fader.

3. The **Tape Outputs** are low-impedance unbalanced RCA jacks which output the program mix and allow you to connect any recording device.

4. The **Stereo Zone Outputs** are low-impedance unbalanced RCA jacks controlled by the **Zone Level** controls.

5. **Mic** is the mic input for the Mic Channel.

6. **Mic** is the mic input for the Mic on Channel 4.

7. **Channels 1-5 Line Inputs** are unbalanced RCA jacks. The **Line Input** is selected with the toggle switch on the front panel. You can connect stereo audio from HiFi VCRs, cassette and reel-to-reel tape decks, DAT machines, CD players, laser discs, tuners, even synthesizers or other mixing consoles.

NOTE: Plug mono audio sources into both Left and Right inputs using a "Y" cable connector.

9. **Phono Inputs on Channels 1, 2 and 3** use unbalanced RCA jacks. Your input signal is fed directly to the **DM1720X's** high-quality RIAA phono preamplifiers so use this position only for moving magnet cartridges. Line level sources will overload the sensitive phono preamps and will sound very bad.

10. **AC Cord.** See safety precautions on page 3 for proper treatment of the power cord.

11. **Voltage Selector.** Set this for the appropriate voltage in your area

Instructions for Connection....

1. Be sure the POWER is OFF. All connections should be made before the unit is turned on.
Always remember "Turn Amps on last and off first!"
2. Use appropriate cables throughout your system: quality shielded audio cables, low capacitance preferred. Speaker cable must be 14-gauge minimum; 12- or 10-gauge is better.
3. Connect your music sources on the rear of the unit. Up to 3 phono and 8 line sources (CD players, cassette decks, tuners, etc.) can be connected.
4. Connect the ground wire from your turntables (and any other sources that come with a ground) to the ground post on the rear panel. This will eliminate most common hum and feedback problems.
5. Connect your DJ mic on the front left side of the unit or on the back of the unit at Mic 1. Connect your second mic at Mic 2 on the back of the unit.
6. Connect your headphones on the front right side of the unit.
7. The OUTPUT MASTER jacks on the rear of the unit are for connecting to the amplifier.

DM1720X CONNECTION DIAGRAM...

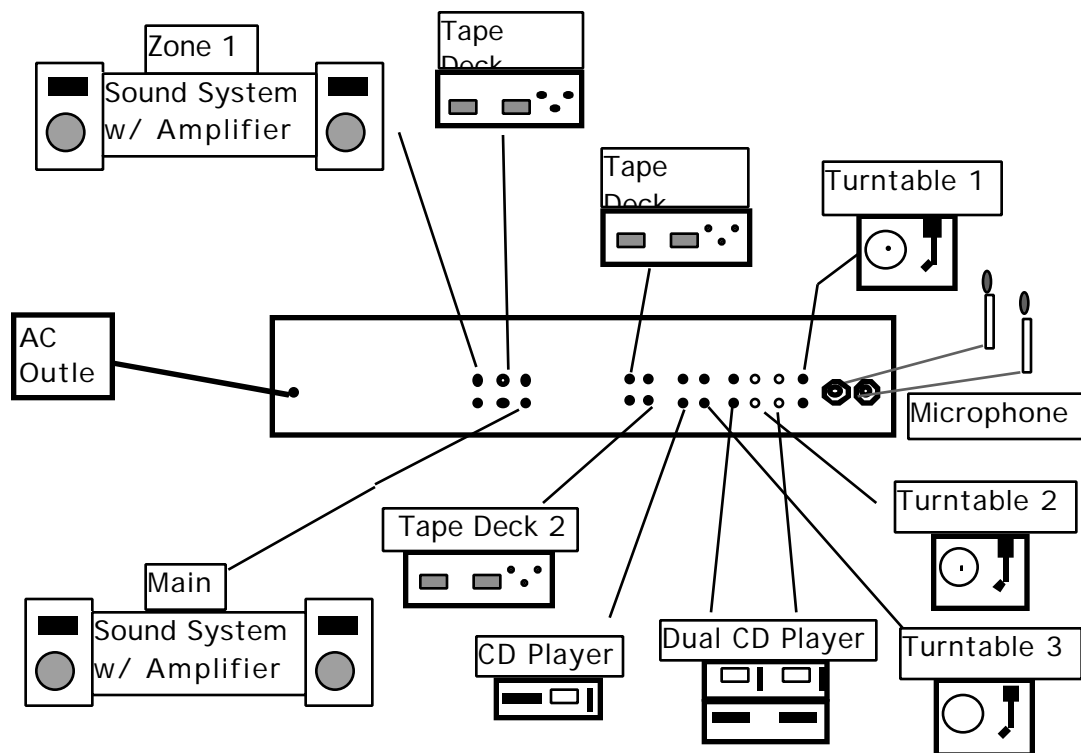

Numark - The Proven Leader in DJ Technology

SPECIFICATIONS...

INPUTS:

Line: 47k input impedance
78mV rms sensitivity (for 1.22 V output)

Mic: 10k input impedance balanced/unbalanced
3 mV rms sensitivity (unbalanced for 1.22 V output)
1.5 mV rms sensitivity (balanced for 1.22 V output)
80 mV rms max input (unbalanced)
40 mV rms max input (balanced)

Phono: 47k input impedance
1.2 mV rms sensitivity @ 1 KHz (for 1.22 V output)

OUTPUTS:

Line: 9V rms max (+20 dBm)
Headphone Amp: .5 watt into 47
Distortion less than .01%

SIGNAL TO NOISE RATIOS (vs. maximum output):

Line: Better than 87 dB
Mic: Better than 86 dB
Phono: Better than 86 dB

FREQUENCY RESPONSE:

Mic: 20 Hz- 20k Hz \pm .5 dB
Line: 20 Hz- 22k Hz \pm .5 dB
Phono: \pm 1 dB except for controlled attenuation of -3 dB
@ 20 Hz to reduce rumble and feedback

CHANNEL EQ:

Bass: \pm 15db @80Hz
Middle: \pm 10db @1KHz
Treble: \pm 15db @12.5KHz

TALKOVER ATTENUATION:

Variable from no cut to -14 dB

POWER CONSUMPTION:

18 Watt typical

BLOCK DIAGRAM...

Numark

Professional Disc Jockey Products

Warranty and Service Information

Numark Industries, LLC and Numark International, Inc. (hereafter "Numark") warrants each new product manufactured and/or supplied by it to be free from defects in material or workmanship under conditions of normal use and service for 360 days, beginning on the date of purchase from an authorized Numark Dealer, but not to exceed 2 years from date of shipment by Numark.

The Numark obligation under this warranty is limited to repairing or replacing, at its option, the product or part(s) therein; which upon examination by Numark shall appear to be defective or not up to factory specifications; providing the Numark product is returned (transportation prepaid) to Numark.

Numark shall not be liable for any damages, consequential or otherwise, resulting from the use and operation of this product and makes no other warranty(s) either express or implied on this product, including any warranty of merchantability.

This warranty does not extend to any of our products which have been subjected to misuse, neglect, accident, incorrect wiring not our own, improper installation, or use in violation of instructions furnished by us, nor extended to units which have been repaired or altered outside of our factory, nor to cases where the serial number thereof has been removed, defaced, or changed, nor to accessories used therewith not of our own manufacture. Numark reserves the right to make changes or improvements in its products, during subsequent production, without incurring the obligation to install such changes or improvements on previously manufactured equipment.

To place this warranty into effect, the enclosed WARRANTY REGISTRATION CARD must be returned to Numark Industries, LLC within thirty (30) days after date of purchase.

This warranty gives you specific legal rights, and you may also have other rights which vary from state to state.

Some states do not allow the exclusion or limitation of incidental or consequential damages so the above limitation or exclusion may not apply to you.

EQUIPMENT TRANSPORT

A Return Authorization number should be obtained from Numark through the addresses or phone numbers below.

It is the customer's obligation, when returning faulty equipment, to properly pack the Numark equipment in its original packaging. Failure to do so may inadequately protect the equipment in transit and, therefore, jeopardize the customer's warranty. The defective Numark equipment should be sent, FREIGHT PREPAID with Return Authorization number to:

NUMARK INDUSTRIES
11 Helmsman Road
North Kingstown RI 02852 USA
Attention: Service Department

Telephone: +1 (401) 295-9000
Fax: +1 (401) 295-5200
E-mail: numark@numark.com